

Component General, Inc.

P/N: CHT- 50 SF

Coaxial Terminations

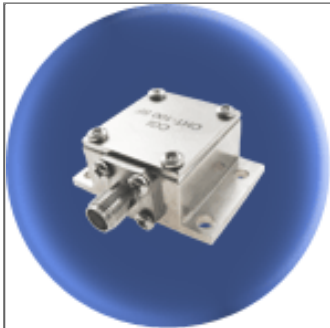

Electrical Specifications

Power:

50 W.

Frequency Range:

DC - 3.0 GHz

3.0 - 6.0 GHz

VSWR (Max.):

1.25:1

1.35:1

Impedance:

50 Ω

Mechanical Specifications

Connector:

Stainless Steel, Passivated.

Contact:

Beryllium Copper, Silver plated.

Housing:

Copper, Nickel plated.

Insulator:

PTFE, Virgin grade.

Part Dimensions

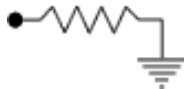
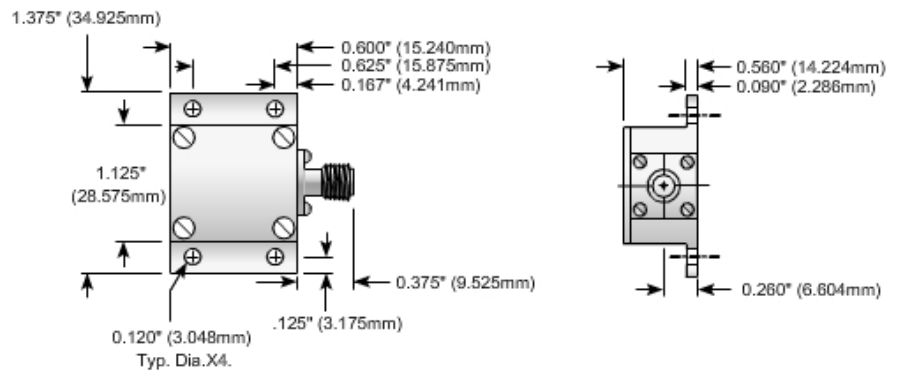

The CHT Series high power coaxial terminations are conduction cooled loads. They are designed to be mounted on a heat sink ground plane or a chill plate. The power ratings require that the base plate of the CHT-15-2 does not exceed 100°C or 85°C for all other sizes.



2445 Success Drive Odessa, FL 33556
727-376-6655 or 800-246-4084