

Component General, Inc.

■ Stripline Chip Resistors

■ MECHANICAL SPECIFICATIONS

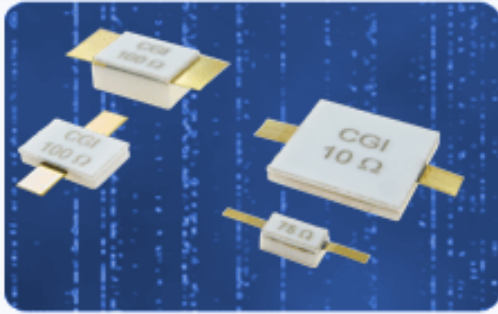

Substrate : Beryllium Oxide Ceramic.

Contact: Beryllium Copper - Gold Plated per MIL-G-45204

Covers : Alumina Ceramic.

Tolerance : $\pm .010$ " Unless specified.

high power chip resistors product selection chart

CGI P/N	Power	Resistance (Ohms)	Standard Tolerance
CCR-100-2	62 W	10 - 1000	5 %
CCR-100-2B	40 W	10 - 1000	5 %
CCR-230-1	150 W	10 - 1000	5 %
CCR-230-2	40 W	10 - 1000	5 %
CCR-250-1	170 W	10 - 1000	5 %
CCR-250-1B	80 W	10 - 1000	5 %
CCR-250-2	330 W	10 - 1000	5 %
CCR-250-2B	100 W	10 - 1000	5 %
CCR-250-2C	160 W	10 - 1000	5 %
CCR-375-1	350 W	10 - 1000	5 %
CCR-375-1B	250 W	10 - 1000	5 %
CCR-500-1	500 W	10 - 1000	5 %
CCR-625-1	700 W	10 - 1000	5 %
CCR-625-2	180 W	10 - 1000	5 %
CCR-1000-1	1000 W	10 - 1000	5 %

[Component General Inc.](#)

2445 Success Drive Odessa, FL 33556 Phone: 727-376-6655 or 800-246-4084

Component General, Inc.

P/N: CCR-100-2

Stripline Chip W/Cover Resistors

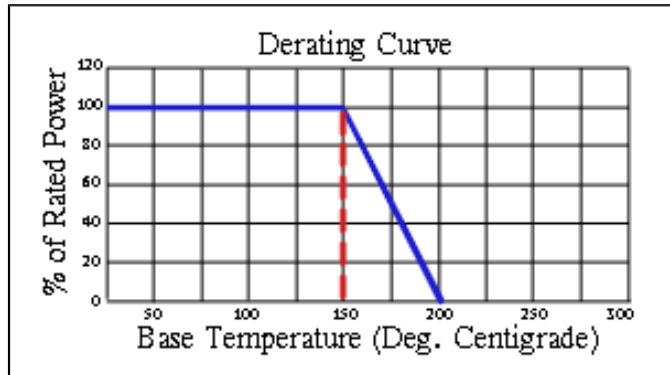
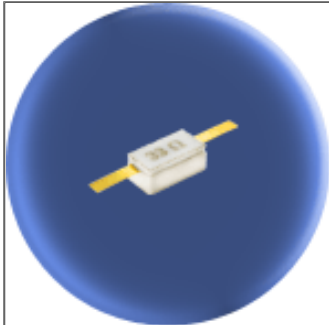

Mechanical Specifications

Substrate:

Beryllium Oxide Ceramic.

Contact:

Beryllium Copper, Gold Plated per MIL-G-45204.

Length: 0.125" Min., Width: 0.040", Thickness 0.004" \pm 0.002".

Covers:

Alumina Ceramic.

Tolerance:

\pm 0.010" unless specified.

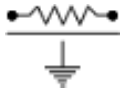

Note: Power is based on infinite and ideal heat sink with the heat sink at 100°C

Electrical Specifications

Resistance Value:

10 - 1000 Ω or as required. Other values available upon request.

Standard Resistance Tolerance:

\pm 5% Other tolerances available upon request.

Part Dimensions

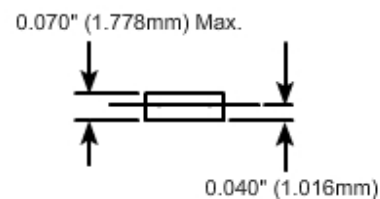
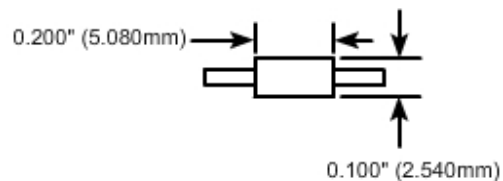

Component General, Inc.

P/N: CCR-100-2B

Stripline Chip W/Cover Resistors

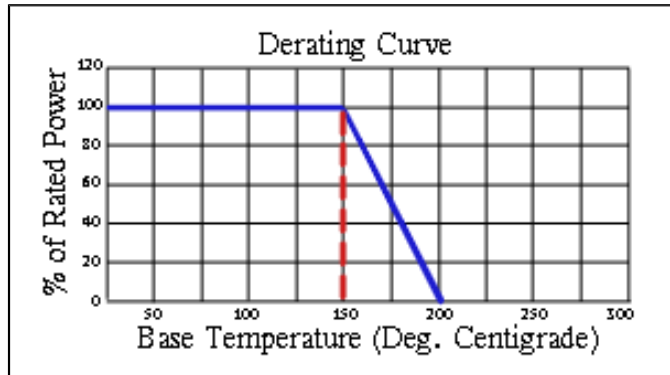
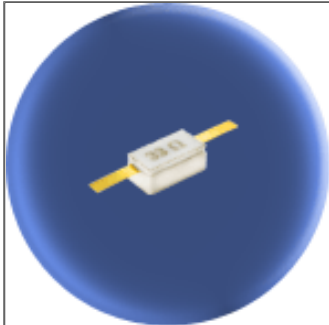

Mechanical Specifications

Substrate:

Beryllium Oxide Ceramic.

Contact:

Beryllium Copper, Gold Plated per MIL-G-45204.

Length: 0.125" Min., Width: 0.040", Thickness 0.004" \pm 0.002".

Covers:

Alumina Ceramic.

Tolerance:

\pm 0.010" unless specified.

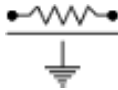

Note: Power is based on infinite and ideal heat sink with the heat sink at 100°C

Electrical Specifications

Resistance Value:

10 - 1000 Ω or as required. Other values available upon request.

Standard Resistance Tolerance:

\pm 5% Other tolerances available upon request.

Part Dimensions

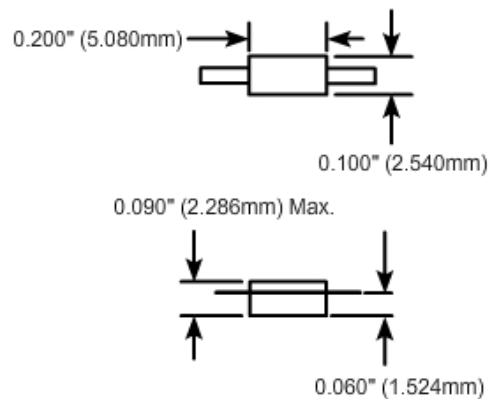

Component General, Inc.

P/N: CCR-230-1

Stripline Chip W/Cover Resistors

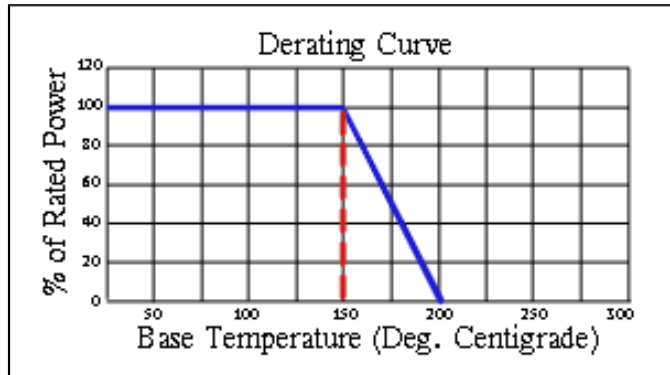
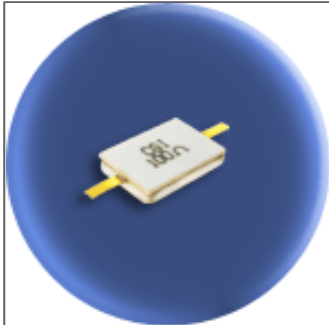

Mechanical Specifications

Substrate:

Beryllium Oxide Ceramic.

Contact:

Beryllium Copper, Gold Plated per MIL-G-45204.

Length: 0.125" Min., Width: 0.040", Thickness 0.004" \pm 0.002".

Covers:

Alumina Ceramic.

Tolerance:

\pm 0.010" unless specified.

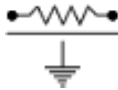

Note: Power is based on infinite and ideal heat sink with the heat sink at 100°C

Electrical Specifications

Resistance Value:

10 - 1000 Ω or as required. Other values available upon request.

Standard Resistance Tolerance:

\pm 5% Other tolerances available upon request.

Part Dimensions

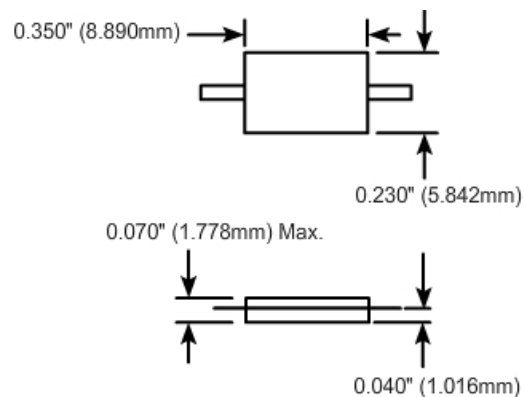

Component General, Inc.

P/N: CCR-230-2

Stripline Chip W/Cover Resistors

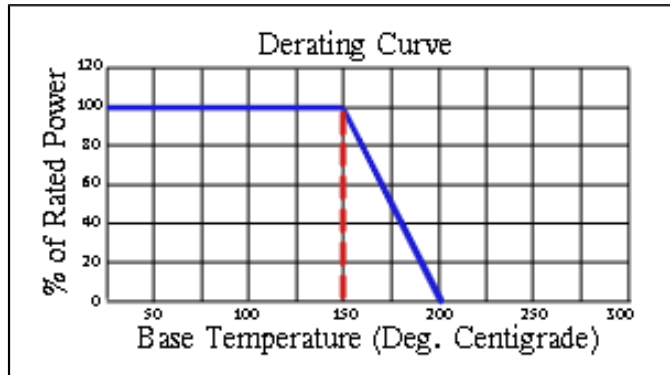
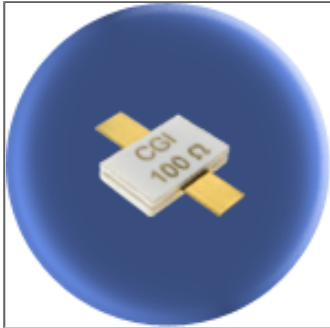

Mechanical Specifications

Substrate:

Beryllium Oxide Ceramic.

Contact:

Beryllium Copper, Gold Plated per MIL-G-45204.

Length: 0.125" Min., Width: 0.120", Thickness 0.004" \pm 0.002".

Covers:

Alumina Ceramic.

Tolerance:

\pm 0.010" unless specified.

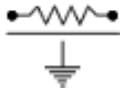

Note: Power is based on infinite and ideal heat sink with the heat sink at 100°C

Electrical Specifications

Resistance Value:

10 - 1000 Ω or as required. Other values available upon request.

Standard Resistance Tolerance:

\pm 5% Other tolerances available upon request.

Part Dimensions

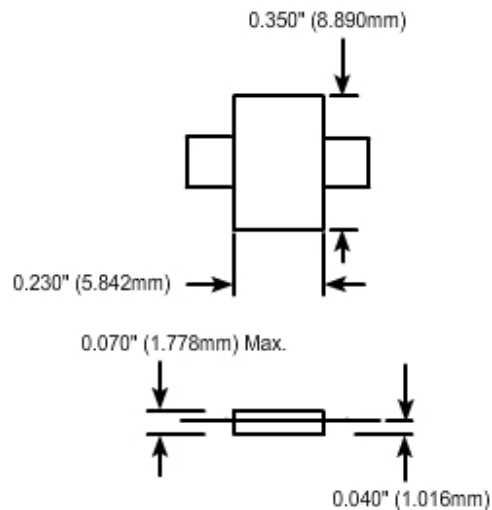

Component General, Inc.

P/N: CCR-250-1

Stripline Chip W/Cover Resistors

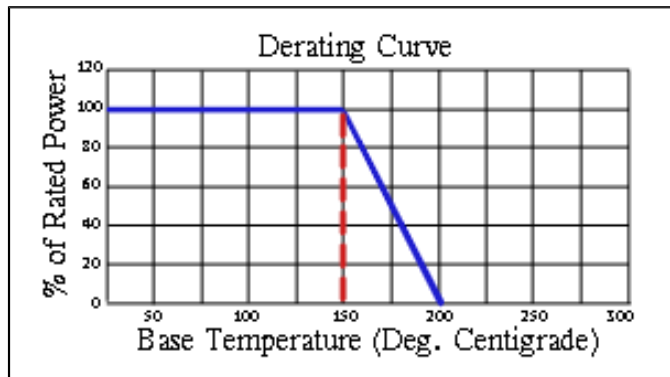
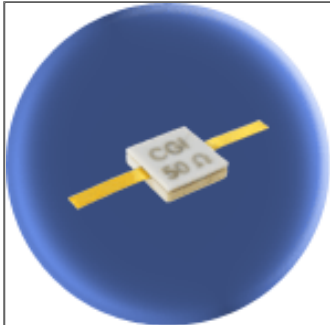

Mechanical Specifications

Substrate:

Beryllium Oxide Ceramic.

Contact:

Beryllium Copper, Gold Plated per MIL-G-45204.

Length: 0.250" Min., Width: 0.060", Thickness 0.004" \pm 0.002".

Covers:

Alumina Ceramic.

Tolerance:

\pm 0.010" unless specified.

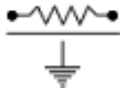

Note: Power is based on infinite and ideal heat sink with the heat sink at 100°C

Electrical Specifications

Resistance Value:

10 - 1000 Ω or as required. Other values available upon request.

Standard Resistance Tolerance:

\pm 5% Other tolerances available upon request.

Part Dimensions

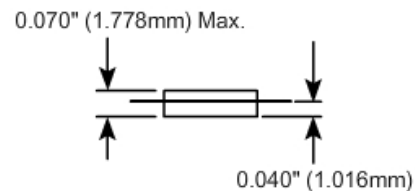
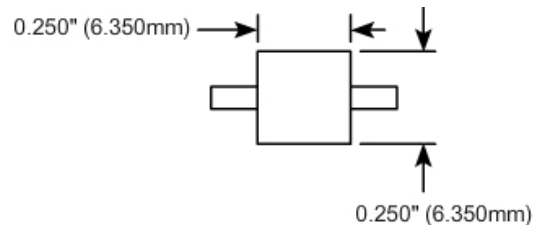

Component General, Inc.

P/N: CCR-250-1B

Stripline Chip W/Cover Resistors

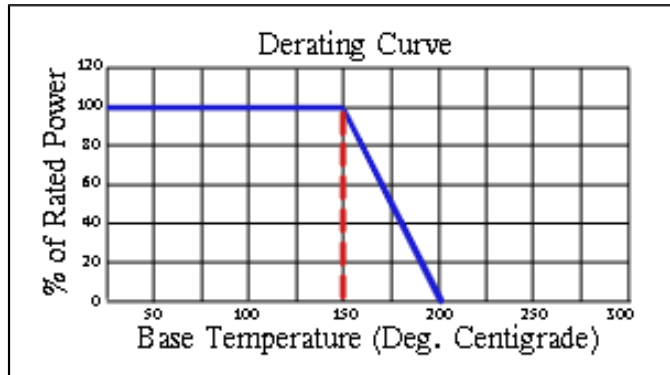
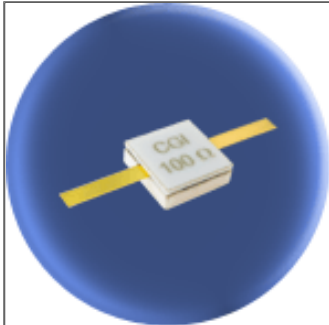

Mechanical Specifications

Substrate:

Beryllium Oxide Ceramic.

Contact:

Beryllium Copper, Gold Plated per MIL-G-45204.

Length: 0.250" Min., Width: 0.060", Thickness 0.004" \pm 0.002".

Covers:

Alumina Ceramic.

Tolerance:

\pm 0.010" unless specified.

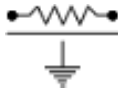

Note: Power is based on infinite and ideal heat sink with the heat sink at 100°C

Electrical Specifications

Resistance Value:

10 - 1000 Ω or as required. Other values available upon request.

Standard Resistance Tolerance:

\pm 5% Other tolerances available upon request.

Part Dimensions

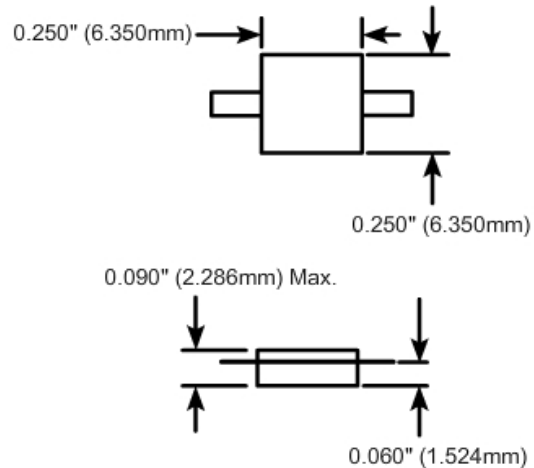

Component General, Inc.

P/N: CCR-250-2

Stripline Chip W/Cover Resistors

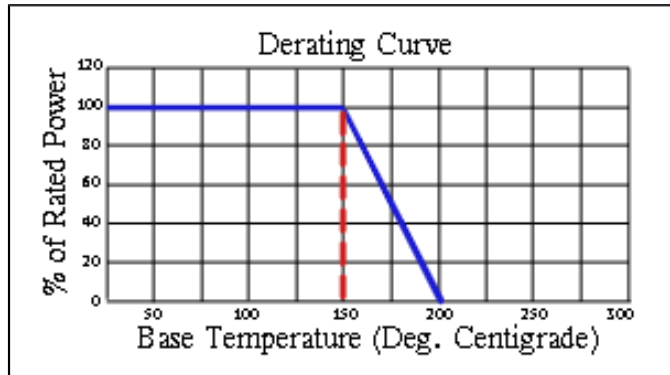
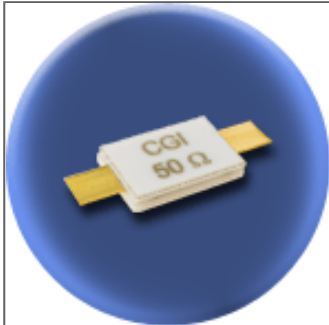

Mechanical Specifications

Substrate:

Beryllium Oxide Ceramic.

Contact:

Beryllium Copper, Gold Plated per MIL-G-45204.

Length: 0.125" Min., Width: 0.120", Thickness 0.004" \pm 0.002".

Covers:

Alumina Ceramic.

Tolerance:

\pm 0.010" unless specified.

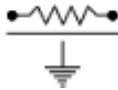

Note: Power is based on infinite and ideal heat sink with the heat sink at 100°C

Electrical Specifications

Resistance Value:

10 - 1000 Ω or as required. Other values available upon request.

Standard Resistance Tolerance:

\pm 5% Other tolerances available upon request.

Part Dimensions

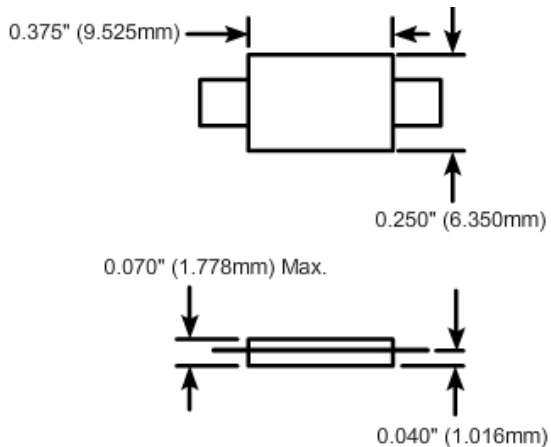

Component General, Inc.

P/N: CCR-250-2B

Stripline Chip W/Cover Resistors

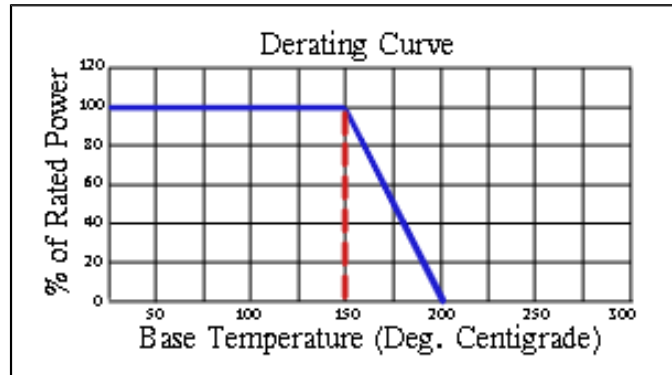
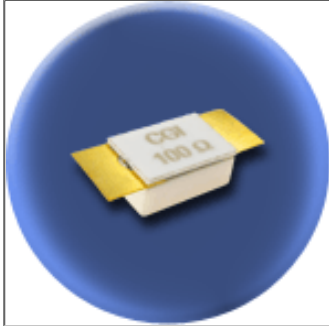

Mechanical Specifications

Substrate:

Beryllium Oxide Ceramic.

Contact:

Beryllium Copper, Gold Plated per MIL-G-45204.

Length 0.125" Min., Width 0.250", Thickness 0.004 ± 0.002 ".

Covers:

Alumina Ceramic.

Tolerance:

± 0.010 " unless specified.

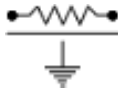

Note: Power is based on infinite and ideal heat sink with the heat sink at 100°C

Electrical Specifications

Resistance Value:

10 - 1000 Ω or as required. Other values available upon request.

Standard Resistance Tolerance:

$\pm 5\%$ Other tolerances available upon request.

Part Dimensions

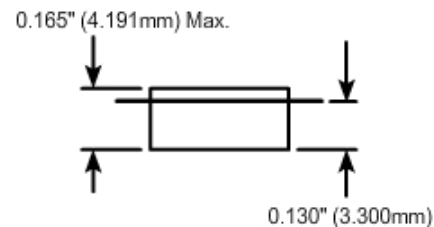
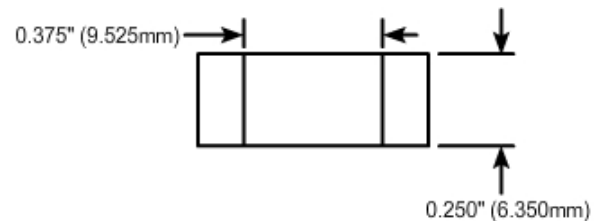

Component General, Inc.

P/N: CCR-250-2C

Stripline Chip W/Cover Resistors

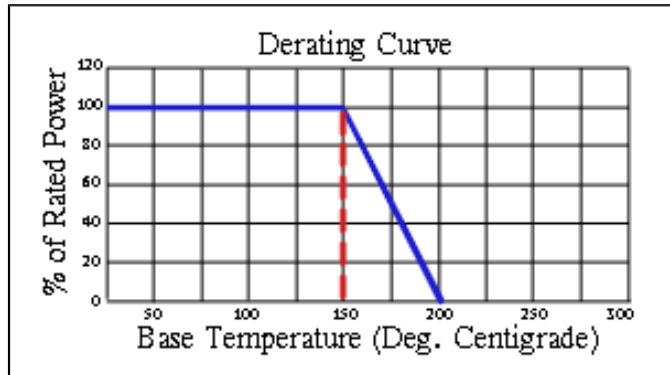
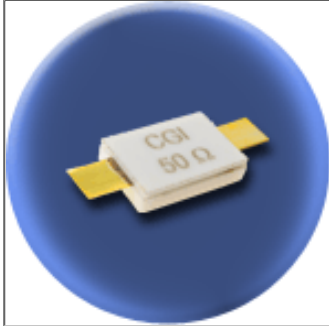

Mechanical Specifications

Substrate:

Beryllium Oxide Ceramic.

Contact:

Beryllium Copper, Gold Plated per MIL-G-45204.

Length: 0.125" Min., Width: 0.120", Thickness 0.004" \pm 0.002".

Covers:

Alumina Ceramic.

Tolerance:

\pm 0.010" unless specified.

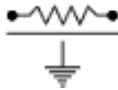

Note: Power is based on infinite and ideal heat sink with the heat sink at 100°C

Electrical Specifications

Resistance Value:

10 - 1000 Ω or as required. Other values available upon request.

Standard Resistance Tolerance:

\pm 5% Other tolerances available upon request.

Part Dimensions

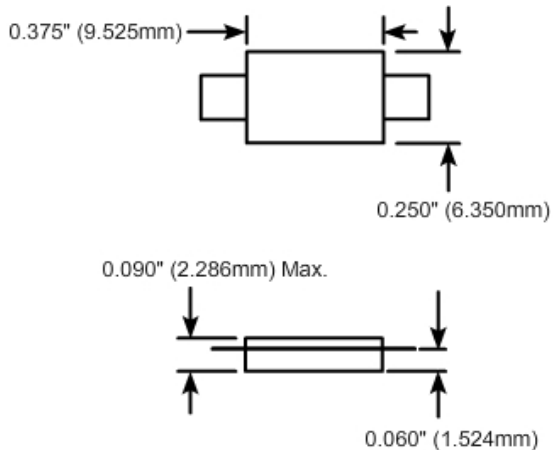

Component General, Inc.

P/N: CCR-375-1

Stripline Chip W/Cover Resistors

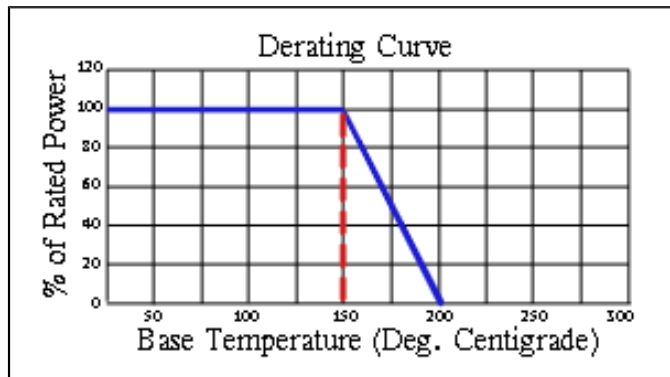
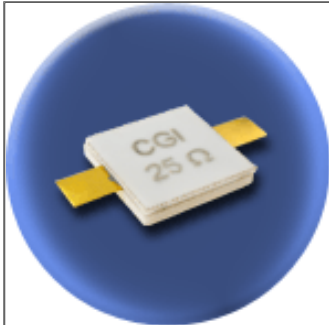

Mechanical Specifications

Substrate:

Beryllium Oxide Ceramic.

Contact:

Beryllium Copper, Gold Plated per MIL-G-45204.

Length: 0.125" Min., Width: 0.120", Thickness 0.004" \pm 0.002".

Covers:

Alumina Ceramic.

Tolerance:

\pm 0.010" unless specified.

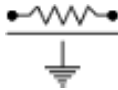

Note: Power is based on infinite and ideal heat sink with the heat sink at 100°C

Electrical Specifications

Resistance Value:

10 - 1000 Ω or as required. Other values available upon request.

Standard Resistance Tolerance:

\pm 5% Other tolerances available upon request.

Part Dimensions

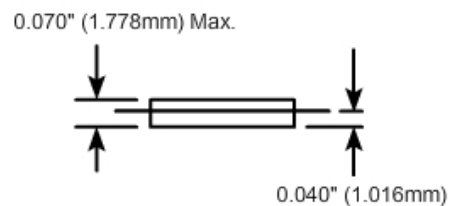
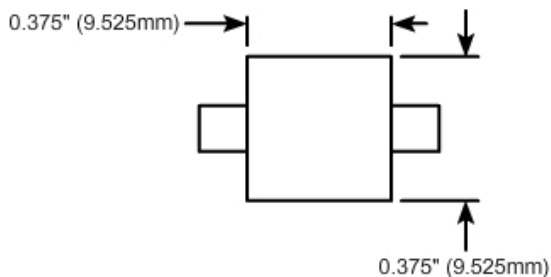

Component General, Inc.

P/N: CCR-375-1B

Stripline Chip W/Cover Resistors

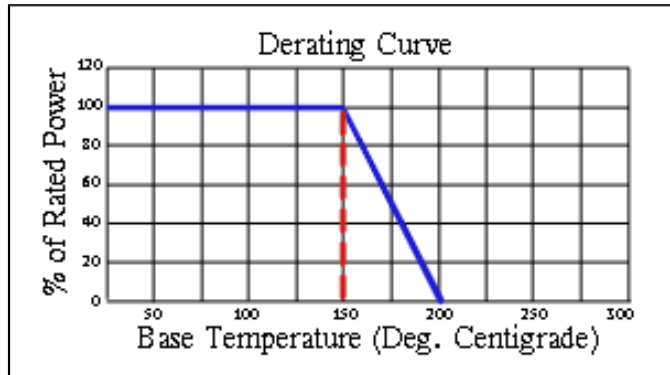
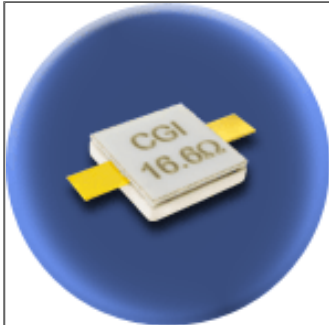

Mechanical Specifications

Substrate:

Beryllium Oxide Ceramic.

Contact:

Beryllium Copper, Gold Plated per MIL-G-45204.

Length: 0.125" Min., Width: 0.120", Thickness 0.004" \pm 0.002".

Covers:

Alumina Ceramic.

Tolerance:

\pm 0.010" unless specified.

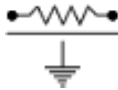

Note: Power is based on infinite and ideal heat sink with the heat sink at 100°C

Electrical Specifications

Resistance Value:

10 - 1000 Ω or as required. Other values available upon request.

Standard Resistance Tolerance:

\pm 5% Other tolerances available upon request.

Part Dimensions

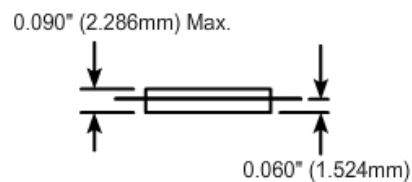
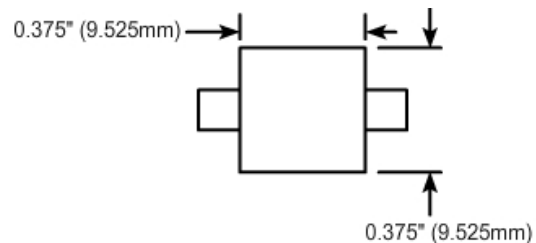

Component General, Inc.

P/N: CCR-375-3

Stripline Chip W/Cover Resistors

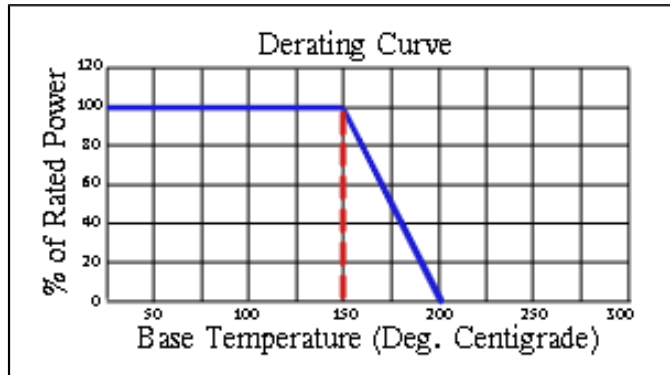
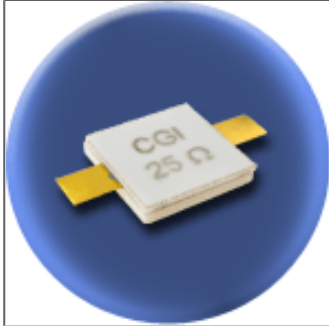

Mechanical Specifications

Substrate:

Beryllium Oxide Ceramic.

Contact:

Beryllium Copper, Gold Plated per MIL-G-45204.

Length: 0.125" Min., Width: 0.120", Thickness 0.004" \pm 0.002".

Covers:

Alumina Ceramic.

Tolerance:

\pm 0.010" unless specified.

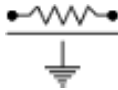

Note: Power is based on infinite and ideal heat sink with the heat sink at 100°C

Electrical Specifications

Resistance Value:

10 - 1000 Ω or as required. Other values available upon request.

Standard Resistance Tolerance:

\pm 5% Other tolerances available upon request.

Part Dimensions

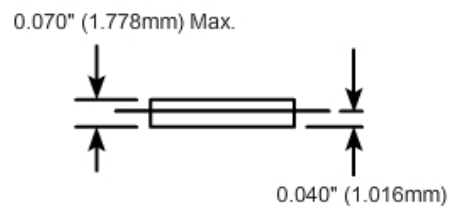
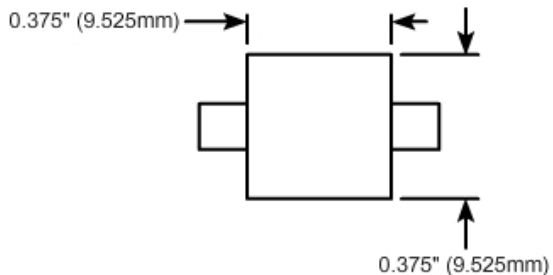

Component General, Inc.

P/N: CCR-500-1

Stripline Chip W/Cover Resistors

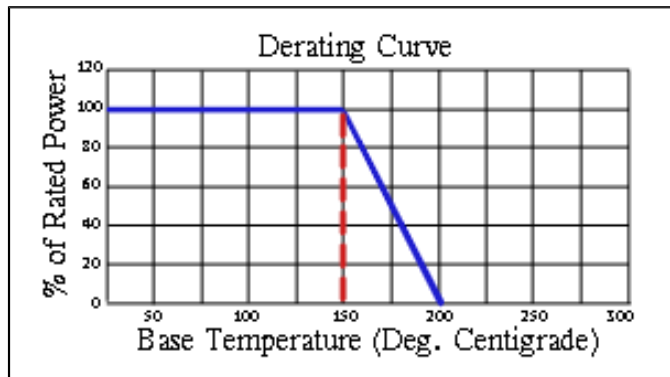
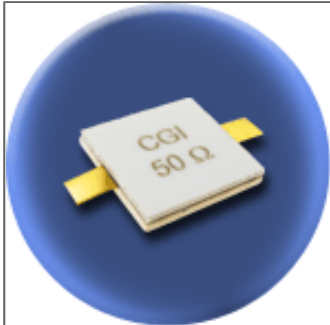

Mechanical Specifications

Substrate:

Beryllium Oxide Ceramic.

Contact:

Beryllium Copper, Gold Plated per MIL-G-45204.

Length: 0.125" Min., Width: 0.120", Thickness 0.004" \pm 0.002".

Covers:

Alumina Ceramic.

Tolerance:

\pm 0.010" unless specified.

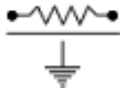

Note: Power is based on infinite and ideal heat sink with the heat sink at 100°C

Electrical Specifications

Resistance Value:

10 - 1000 Ω or as required. Other values available upon request.

Standard Resistance Tolerance:

\pm 5% Other tolerances available upon request.

Part Dimensions

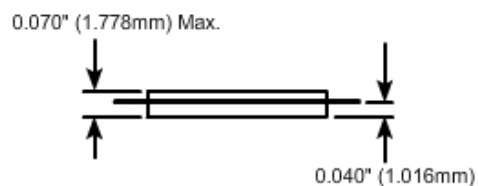
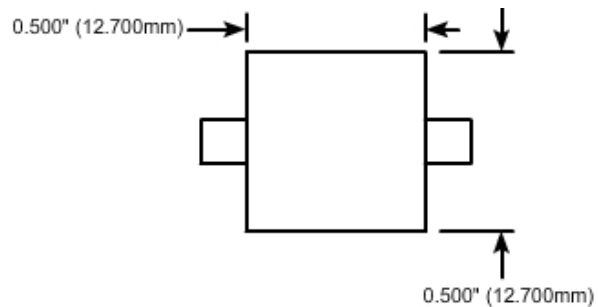

Component General, Inc.

P/N: CCR-625-1

Stripline Chip W/Cover Resistors

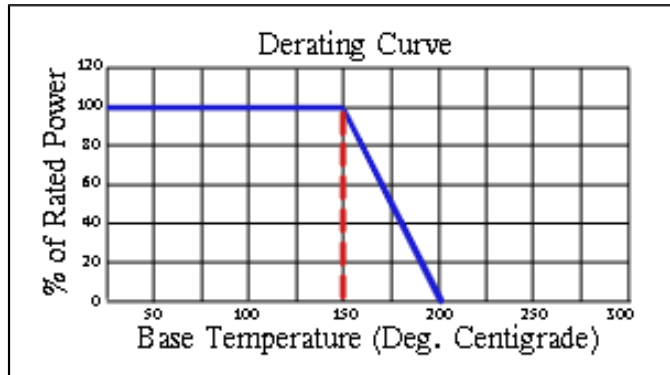
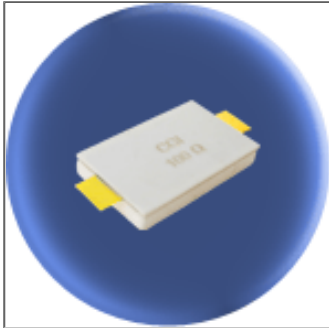

Mechanical Specifications

Substrate:

Beryllium Oxide Ceramic.

Contact:

Beryllium Copper, Gold Plated per MIL-G-45204.

Length: 0.125" Min., Width: 0.250", Thickness 0.004" \pm 0.002".

Covers:

Alumina Ceramic.

Tolerance:

\pm 0.010" unless specified.

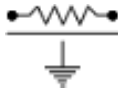

Note: Power is based on infinite and ideal heat sink with the heat sink at 100°C

Electrical Specifications

Resistance Value:

10 - 1000 Ω or as required. Other values available upon request.

Standard Resistance Tolerance:

\pm 5% Other tolerances available upon request.

Part Dimensions

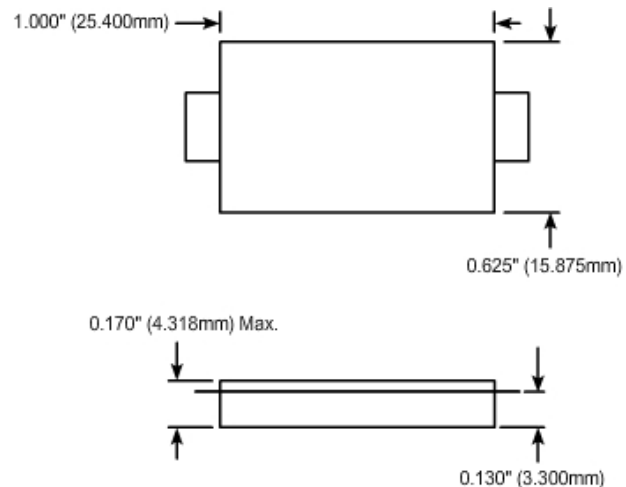

Component General, Inc.

P/N: CCR-625-2

Stripline Chip W/Cover Resistors

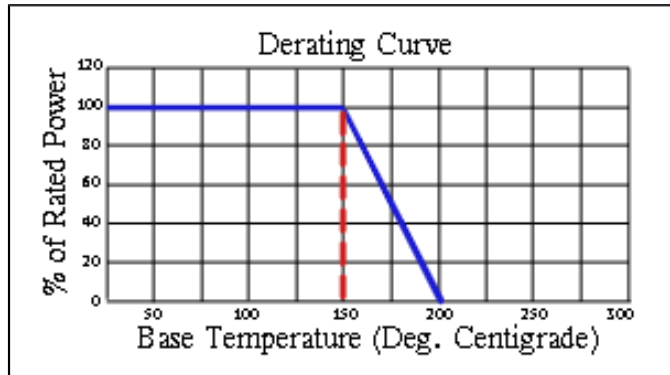
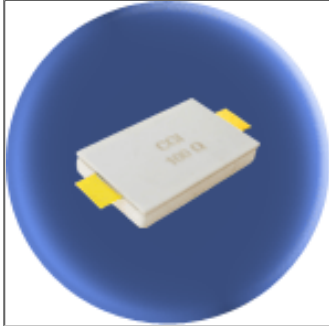

Mechanical Specifications

Substrate:

Beryllium Oxide Ceramic.

Contact:

Beryllium Copper, Gold Plated per MIL-G-45204.

Length: 0.125" Min., Width: 0.250", Thickness 0.004" \pm 0.002".

Covers:

Alumina Ceramic.

Tolerance:

\pm 0.010" unless specified.

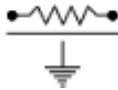

Note: Power is based on infinite and ideal heat sink with the heat sink at 100°C

Electrical Specifications

Resistance Value:

10 - 1000 Ω or as required. Other values available upon request.

Standard Resistance Tolerance:

\pm 5% Other tolerances available upon request.

Part Dimensions

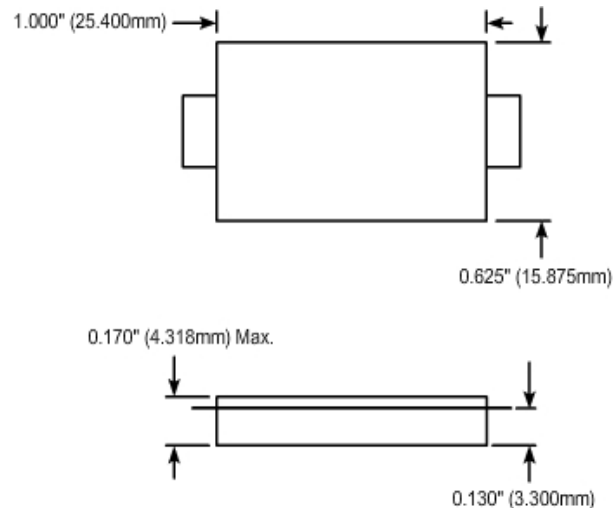

Component General, Inc.

P/N: CCR-1000-1

Stripline Chip W/Cover Resistors

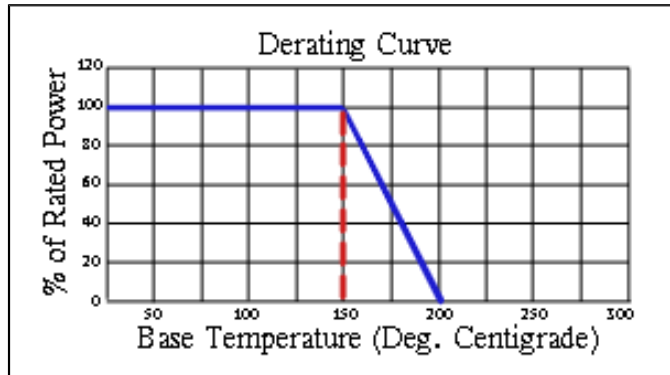
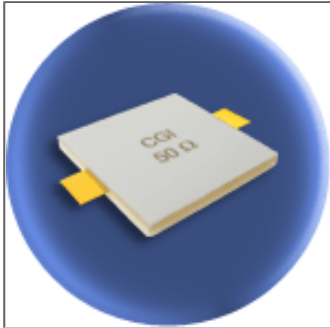

Mechanical Specifications

Substrate:

Beryllium Oxide Ceramic.

Contact:

Beryllium Copper, Gold Plated per MIL-G-45204.

Length: 0.125" Min., Width: 0.250", Thickness 0.004" \pm 0.002".

Covers:

Alumina Ceramic.

Tolerance:

\pm 0.010" unless specified.

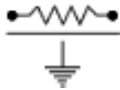

Note: Power is based on infinite and ideal heat sink with the heat sink at 100°C

Electrical Specifications

Resistance Value:

10 - 1000 Ω or as required. Other values available upon request.

Standard Resistance Tolerance:

\pm 5% Other tolerances available upon request.

Part Dimensions

